

Artwork Note:

Please Note:
 All artwork is printed in CMYK colour space. To ensure your correct artwork please convert all to an equivalent CMYK breakup. Please be aware that slight colour variation may occur in the printing process from monitor to output. Rasterised artwork is printed at 300 dpi. We advise full sized artwork supplied at 300 dpi for best quality, we can work to 72dpi at a low quality print. Our visuals are copyright protected & are not be forwarded to other companies otherwise an art working fee will be enforced.

- Please check the following details are correct:
1. All company details.
 2. Spelling.
 3. Phone numbers, Addresses + URL's.
 4. Positioning of artwork.
 5. Colours.
 6. Correct size.

Please fax back to 01295 263750 or sign, scan, attach & reply to your emailed quote.

Print Name. _____
 Signature. _____

Quote reference:

2x2m Frame TBC

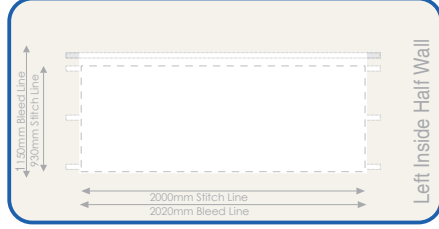

Left Inside Half Wall

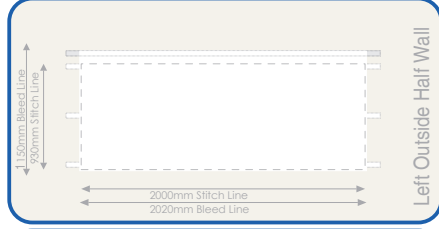

Left Outside Half Wall

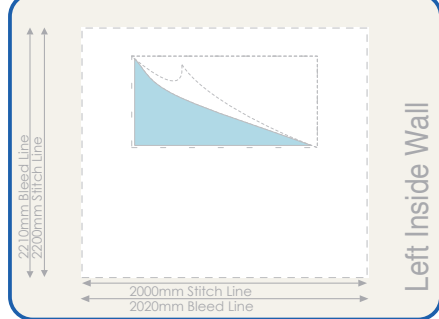

Left Inside Wall

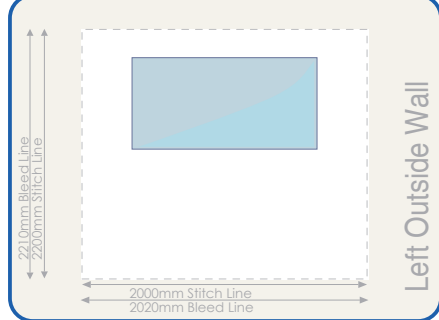

Left Outside Wall

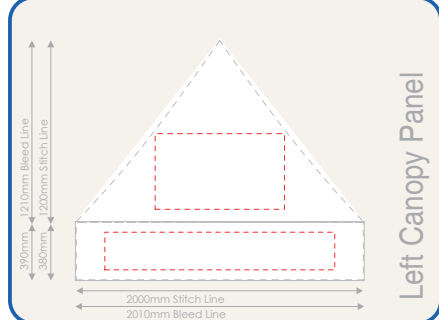

Left Canopy Panel

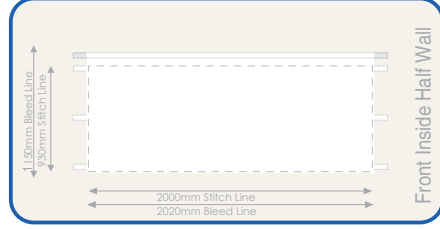

Front Inside Half Wall

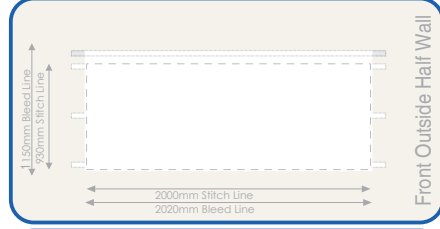

Front Outside Half Wall

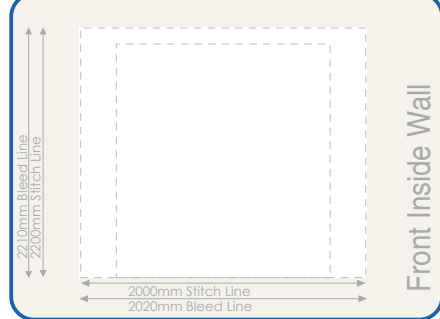

Front Inside Wall

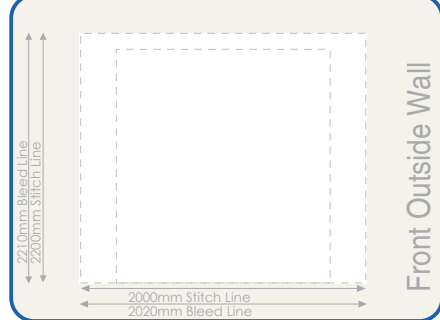

Front Outside Wall

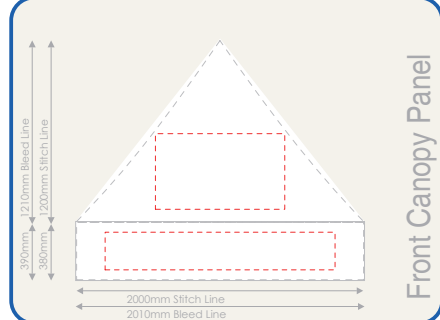

Front Canopy Panel

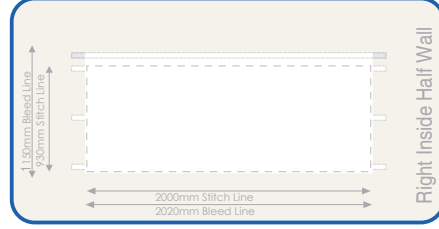

Right Inside Half Wall

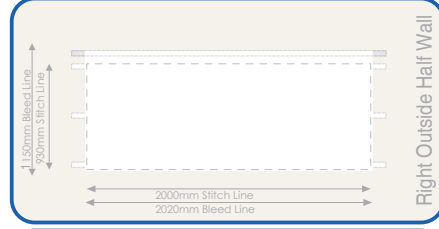

Right Outside Half Wall

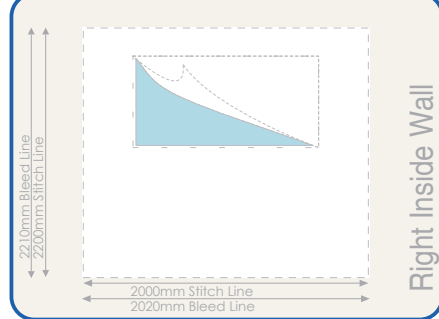

Right Inside Wall

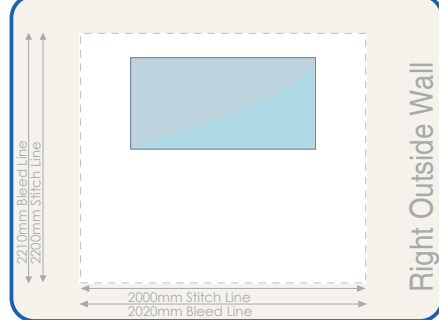

Right Outside Wall

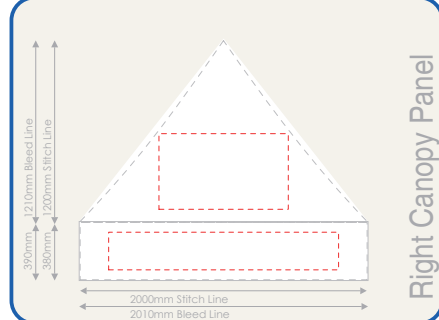

Right Canopy Panel

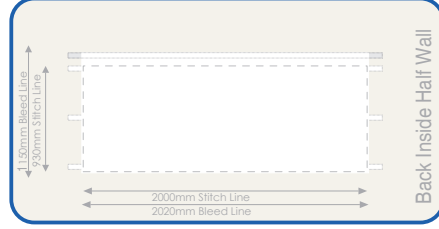

Back Inside Half Wall

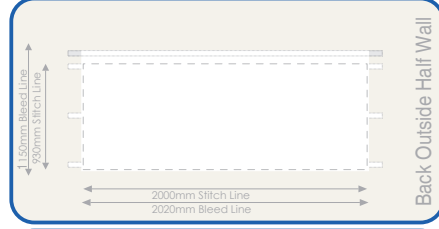

Back Outside Half Wall



Back Inside Wall

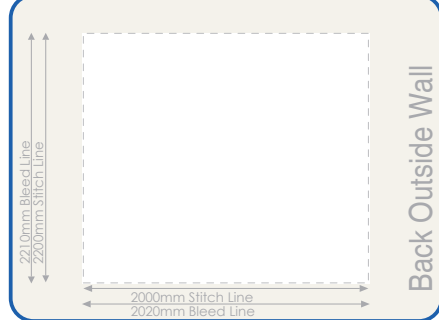

Back Outside Wall

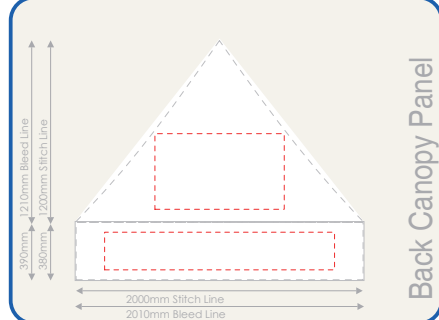

Back Canopy Panel

2x2m Frame TBC

Printed Sections:

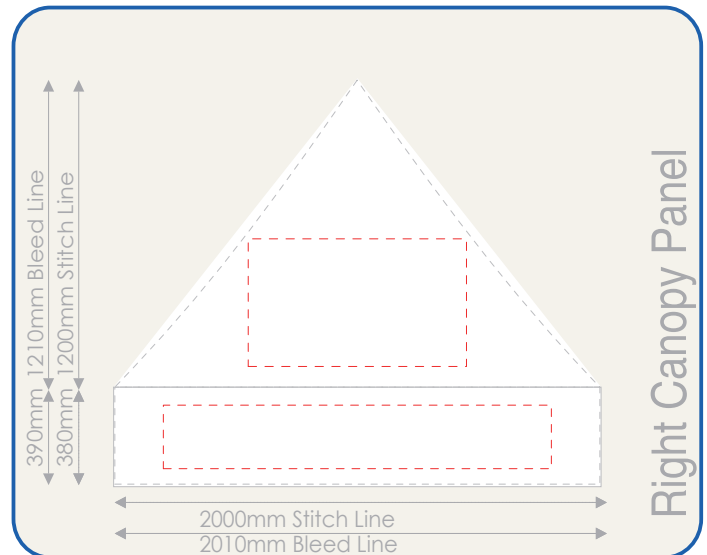
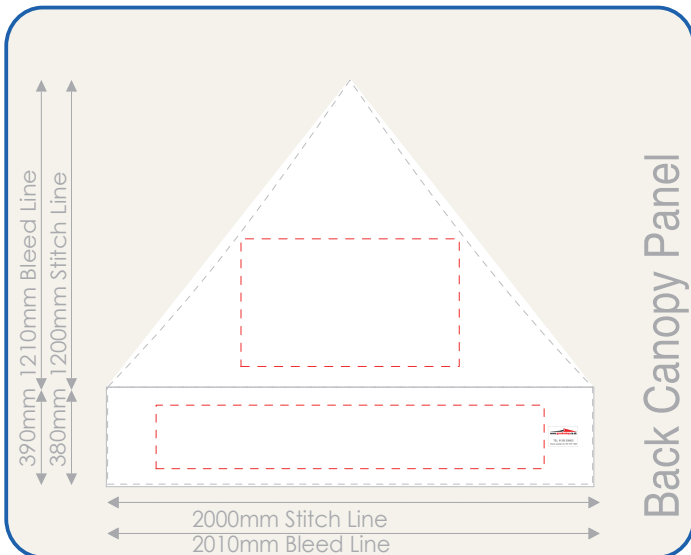
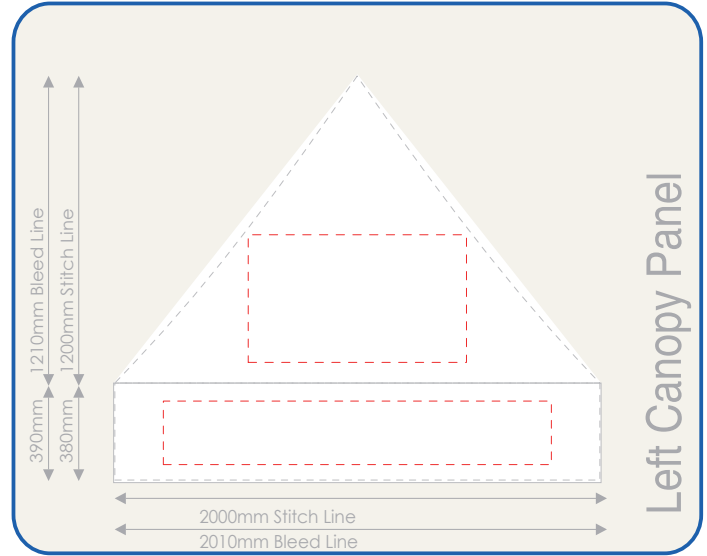
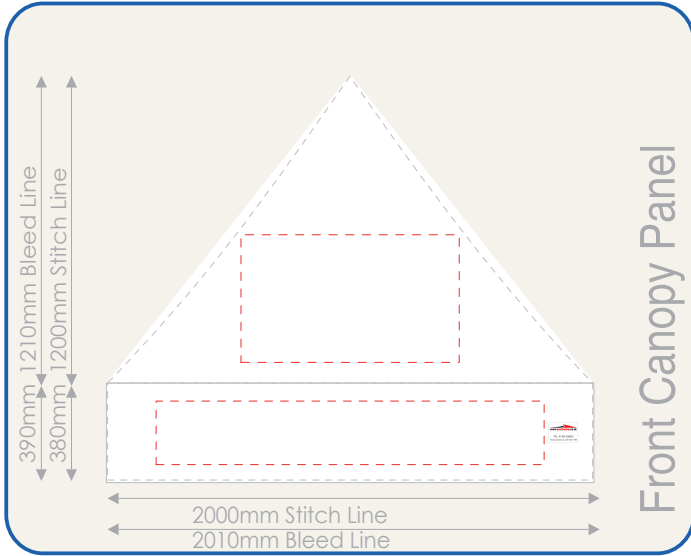

Artwork Note:

Red dotted boxes indicates our in house print areas

Please Note:

All artwork is printed in CMYK colour space. To ensure your correct artwork please convert all to an equivalent CMYK breakup with all fonts & strokes converted to outlines. Please be aware that slight colour variation may occur in the printing process from monitor to output. Rasterised artwork is printed at 300dpi. We advise full sized artwork supplied at 300dpi for best quality, we can work to 30dpi at a low quality print, Pixelation appears at 72dpi. Our visuals are copyright protected & are not be forwarded to other companies otherwise an art working fee will be enforced.

Please check the following details are correct:

- 1. All company details.
- 2. Spelling.
- 3. Phone numbers, Addresses + URL's.
- 4. Positioning of artwork.
- 5. Colours.
- 6. Correct size.

Please fax back to 01295 263750 or sign, scan, attach & reply to your emailed quote.

Print Name. _____

Signature. _____

Artwork Note:

Please check the following details are correct:

- 1. All company details.
- 2. Spelling.
- 3. Phone numbers, Addresses + URL's.
- 4. Positioning of artwork.
- 5. Colours.
- 6. Correct size.

Please fax back to 01295 263750
or sign, scan, attach & reply to your emailed quote.

Print Name. _____

Signature. _____

Please Note:

All artwork is printed in CMYK colour space. To ensure your correct artwork please convert all to an equivalent CMYK breakup.
Please be aware that slight colour variation may occur in the printing process from monitor to output. Rasterised artwork is printed at 300 dpi. We advise full sized artwork supplied at 300 dpi for best quality, we can work to 72dpi at a low quality print.
Our visuals are copyright protected & are not be forwarded to other companies otherwise an art working fee will be enforced.

Note: "Halfwalls" are folded over a crossbar and stitched onto the inside.
For front printing the artwork should be up to the designated top of the half wall stich line. Inside artwork is not available.

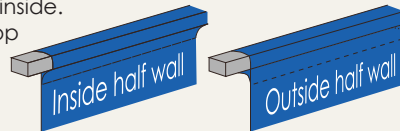

Front

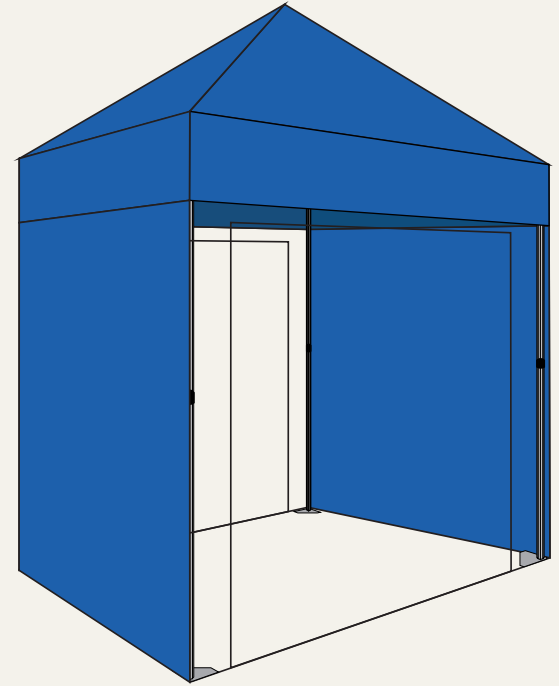

Back

