

Quote reference:

# 1.5x1.5m Frame TBC

Printed Sections:

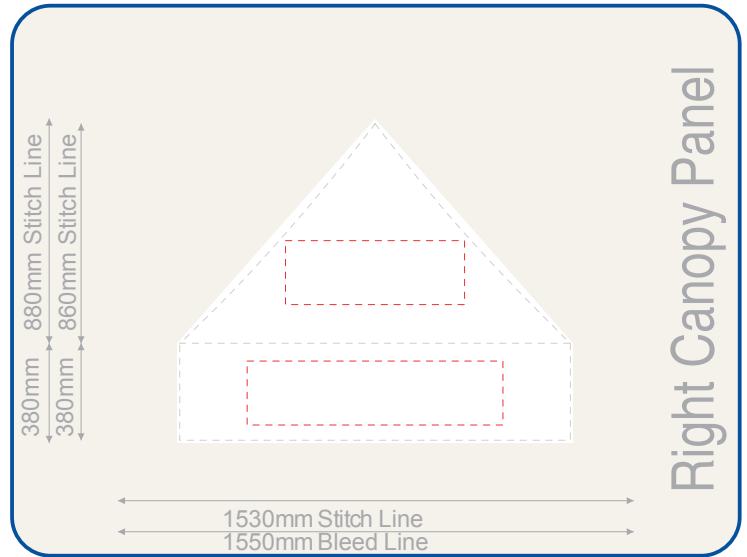
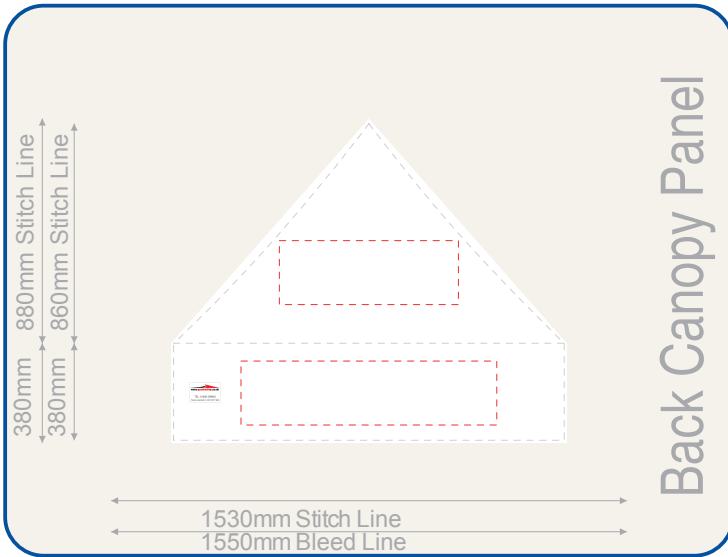
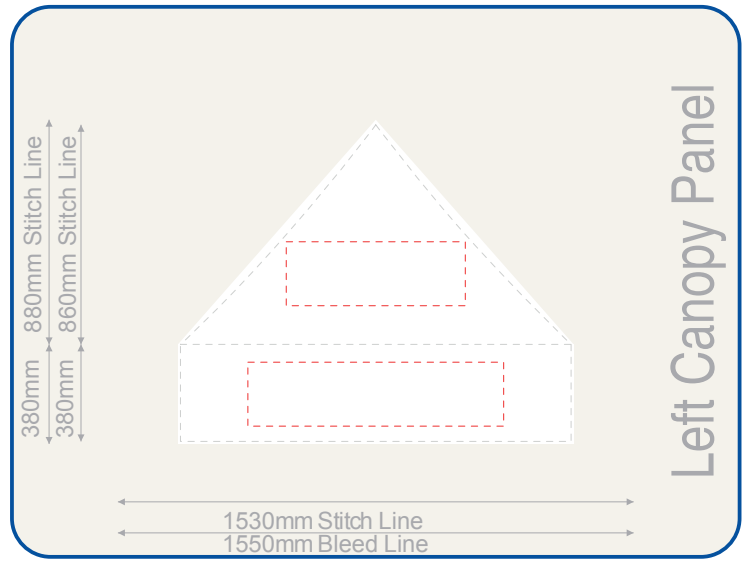
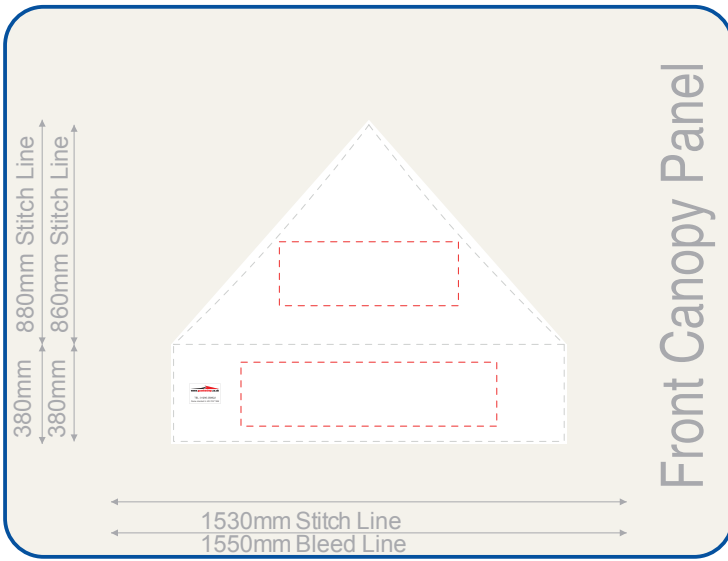

Artwork Note:

**Red dotted boxes indicates our in house print areas**

Please check the following details are correct:

- 1. All company details.
- 2. Spelling.
- 3. Phone numbers, Addresses + URL's.
- 4. Positioning of artwork.
- 5. Colours.
- 6. Correct size.

Please fax back to 01295 263750

or sign, scan, attach & reply to your emailed quote.

Print Name. \_\_\_\_\_

Signature. \_\_\_\_\_

Please Note:

All artwork is printed in CMYK colour space. To ensure your correct artwork please convert all to an equivalent CMYK breakup. Please be aware that slight colour variation may occur in the printing process from monitor to output. Rasterised artwork is printed at 300 dpi. We advise full sized artwork supplied at 300 dpi for best quality, we can work to 72dpi at a low quality print. Our visuals are copyright protected & are not be forwarded to other companies otherwise an art working fee will be enforced.

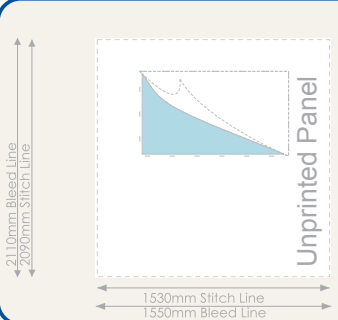

2110mm Bleed Line  
2090mm Stitch Line

1530mm Stitch Line  
1550mm Bleed Line

Unprinted Panel

Left Inside Wall

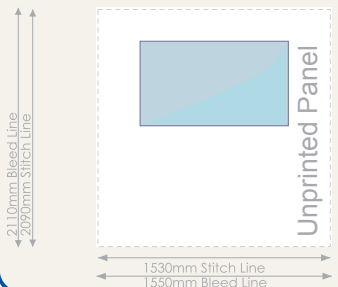

2110mm Bleed Line  
2090mm Stitch Line

1530mm Stitch Line  
1550mm Bleed Line

Unprinted Panel

Left Outside Wall

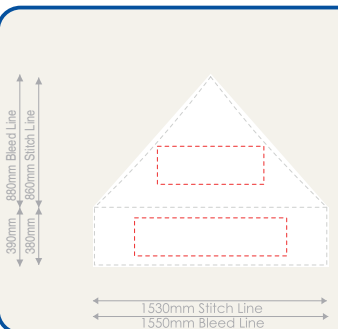

390mm  
880mm Bleed Line  
380mm  
860mm Stitch Line

1530mm Stitch Line  
1550mm Bleed Line

Unprinted Panel

Left Canopy Panel

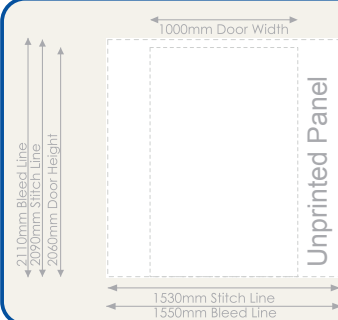

2110mm Bleed Line  
2090mm Stitch Line  
2060mm Door Height

1000mm Door Width

1530mm Stitch Line  
1550mm Bleed Line

Unprinted Panel

Front Inside Wall

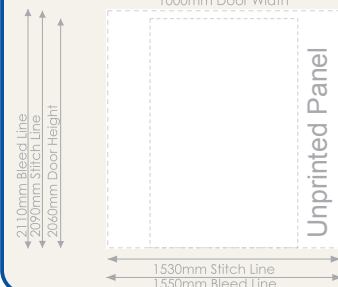

2110mm Bleed Line  
2090mm Stitch Line  
2060mm Door Height

1000mm Door Width

1530mm Stitch Line  
1550mm Bleed Line

Unprinted Panel

Front Outside Wall

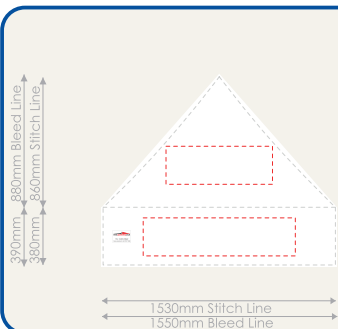

390mm  
880mm Bleed Line  
380mm  
860mm Stitch Line

1530mm Stitch Line  
1550mm Bleed Line

Unprinted Panel

Front Canopy Panel

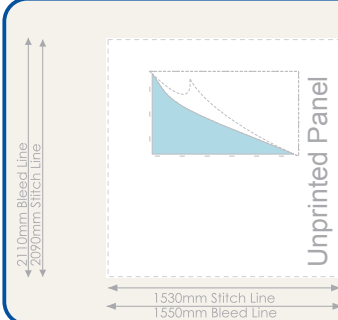

2110mm Bleed Line  
2090mm Stitch Line

1530mm Stitch Line  
1550mm Bleed Line

Unprinted Panel

Right Inside Wall

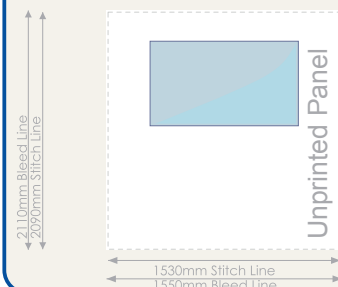

2110mm Bleed Line  
2090mm Stitch Line

1530mm Stitch Line  
1550mm Bleed Line

Unprinted Panel

Right Outside Wall

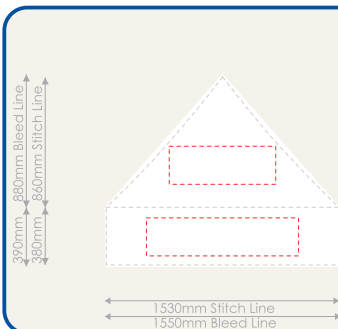

390mm  
880mm Bleed Line  
380mm  
860mm Stitch Line

1530mm Stitch Line  
1550mm Bleed Line

Unprinted Panel

Right Canopy Panel

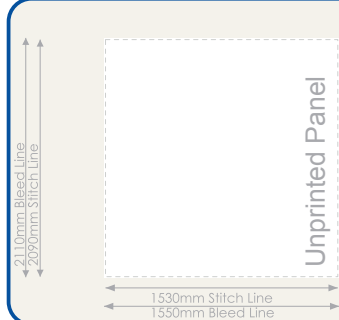

2110mm Bleed Line  
2090mm Stitch Line

1530mm Stitch Line  
1550mm Bleed Line

Unprinted Panel

Back Inside Wall

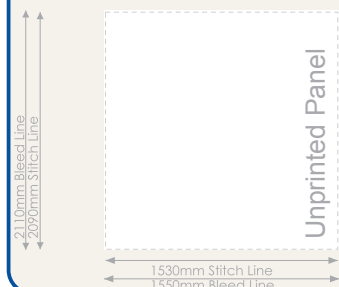

2110mm Bleed Line  
2090mm Stitch Line

1530mm Stitch Line  
1550mm Bleed Line

Unprinted Panel

Back Outside Wall

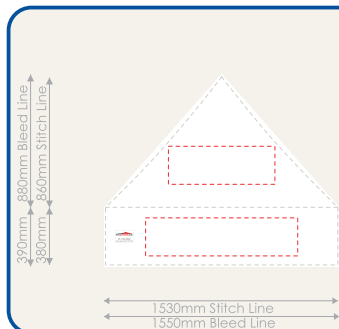

390mm  
880mm Bleed Line  
380mm  
860mm Stitch Line

1530mm Stitch Line  
1550mm Bleed Line

Unprinted Panel

Back Canopy Panel

Artwork Note:

Please Note:

All artwork is printed in CMYK colour space. To ensure your correct artwork please convert all to an equivalent CMYK breakup. Please be aware that slight colour variation may occur in the printing process from monitor to output. Rasterised artwork is printed at 300 dpi. We advise full sized artwork supplied at 300 dpi for best quality, we can work to 72dpi at a low quality print. Our visuals are copyright protected & are not be forwarded to other companies otherwise an art working fee will be enforced.

Please check the following details are correct:

1. All company details. \_\_\_\_\_
2. Spelling. \_\_\_\_\_
3. Phone numbers, Addresses + URL's. \_\_\_\_\_
4. Positioning of artwork. \_\_\_\_\_
5. Colours. \_\_\_\_\_
6. Correct size. \_\_\_\_\_

Please fax back to 01295 261087  
or sign, scan, attach & reply to your emailed quote.

Print Name. \_\_\_\_\_

Signature. \_\_\_\_\_

Quote reference:

1.5x1.5m Frame TBC

[www.gazeboshop.co.uk](http://www.gazeboshop.co.uk)

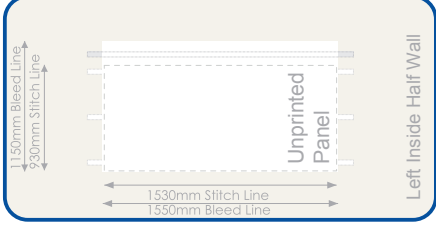

Left Inside Half Wall

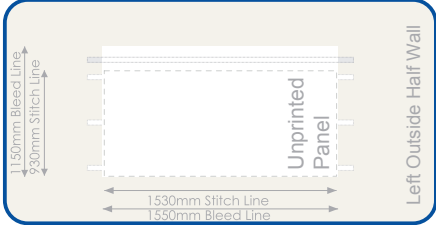

Left Outside Half Wall

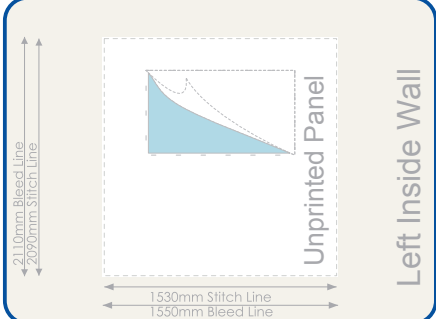

Left Inside Wall

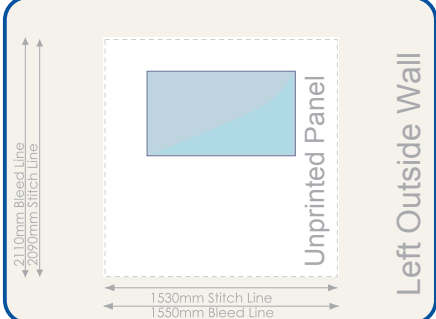

Left Outside Wall

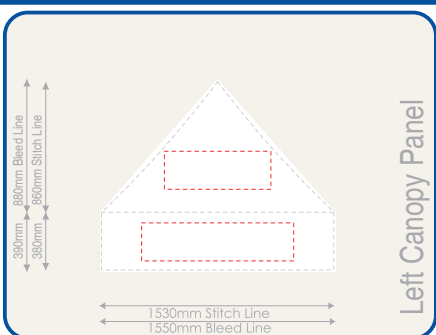

Left Canopy Panel

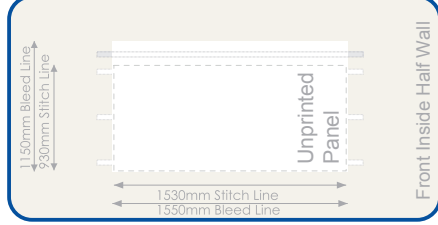

Front Inside Half Wall

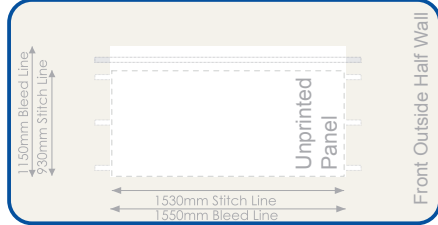

Front Outside Half Wall

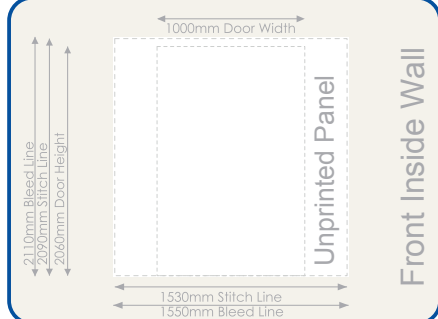

Front Inside Wall

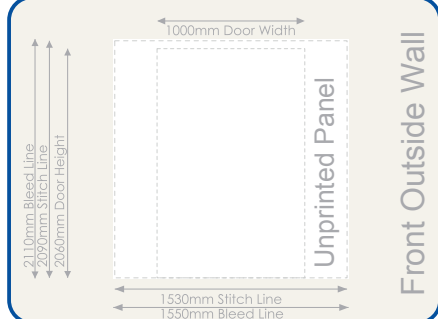

Front Outside Wall

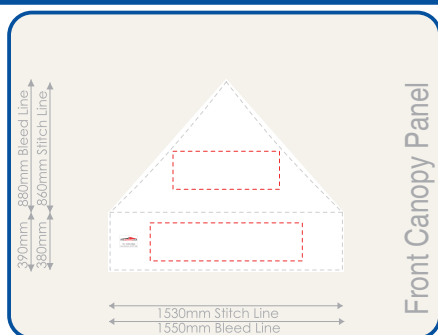

Front Canopy Panel

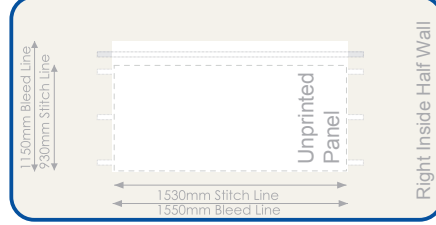

Right Inside Half Wall

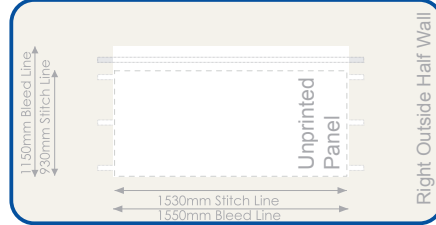

Right Outside Half Wall

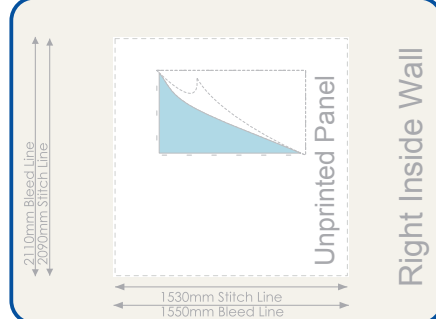

Right Inside Wall

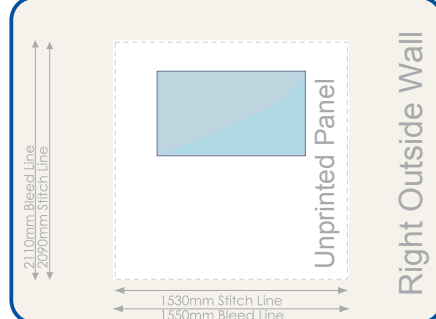

Right Outside Wall

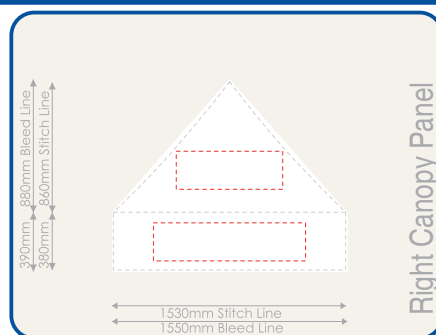

Right Canopy Panel

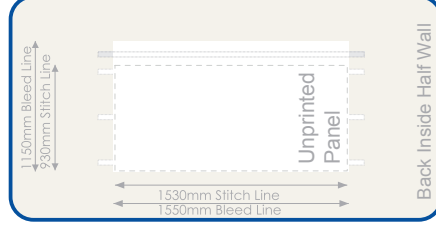

Back Inside Half Wall

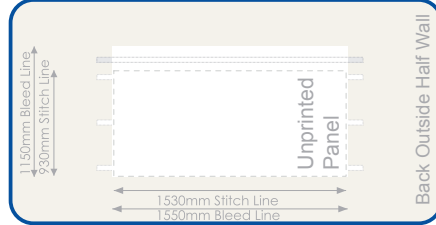

Back Outside Half Wall

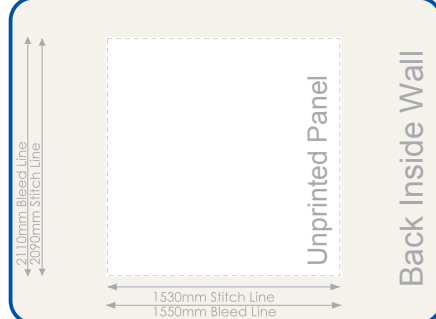

Back Inside Wall

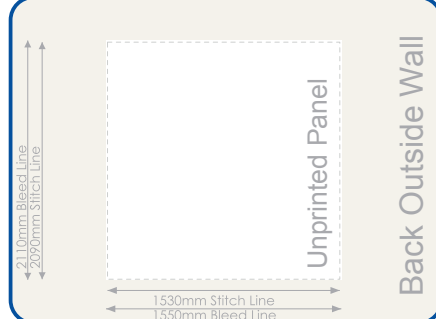

Back Outside Wall

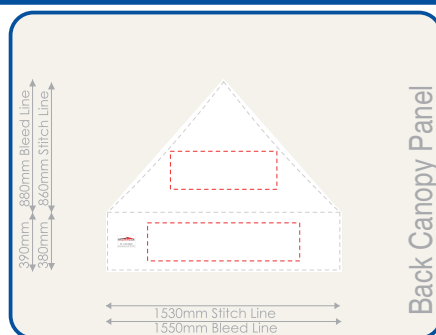

Back Canopy Panel

Printed Sections:  
This template is designed to a 2 + 1.5% scale of the final product

Artwork Note:

Please check the following details are correct:

1. All company details.
2. Spelling.
3. Phone numbers, Addresses + URL's.
4. Positioning of artwork.
5. Colours.
6. Correct size.

Please fax back to 01295 261087  
or sign, scan, attach & reply to your emailed quote.

Print Name. \_\_\_\_\_

Signature. \_\_\_\_\_

Please Note:

All artwork is printed in CMYK colour space. To ensure your correct artwork please convert all to an equivalent CMYK breakup.

Please be aware that slight colour variation may occur in the printing process from monitor to output. Rasterised artwork is printed at 300 dpi. We advise full sized artwork supplied at 300 dpi for best quality. We can print from 300dpi to 30dpi; Pixelation appears at 72dpi, this is the minimum size recommended. Our visuals are copyright protected & are not be forwarded to other companies otherwise an art working fee will be enforced

Note: "Halfwalls" are folded over a crossbar and stitched onto the inside.

For front printing the artwork should be up to the designated top of the half wall stitch line. Inside artwork is not available.

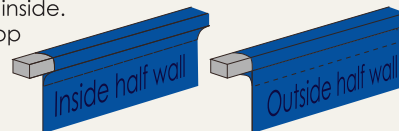

Front



Back

