

Left Canopy Panel

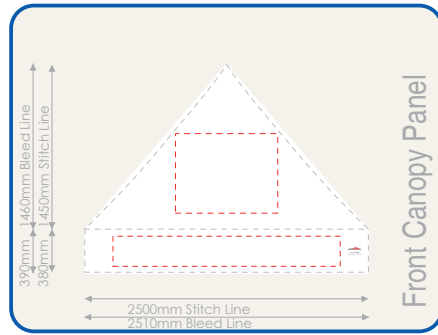

Front Canopy Panel

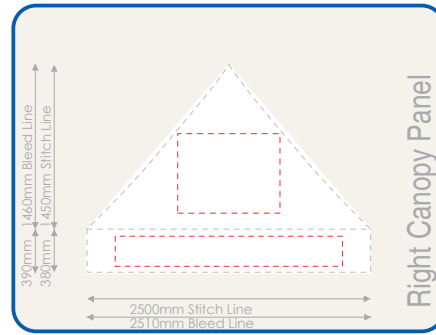

Right Canopy Panel

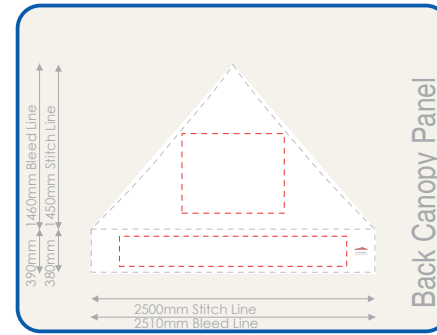

Back Canopy Panel

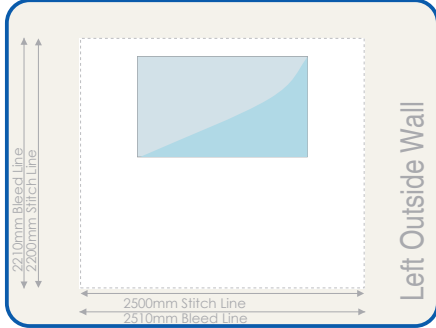

Left Outside Wall

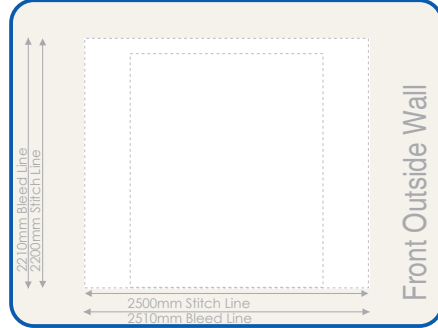

Front Outside Wall

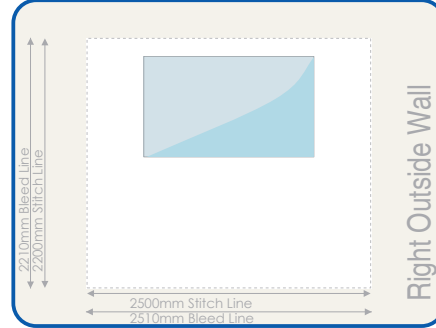

Right Outside Wall

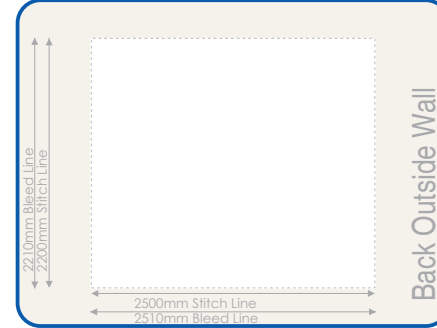

Back Outside Wall

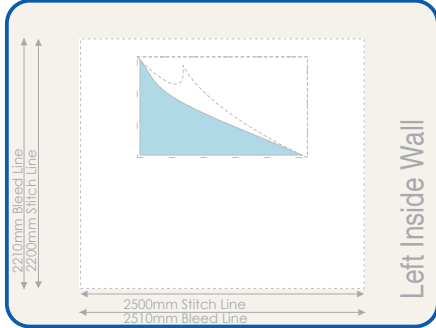

Left Inside Wall

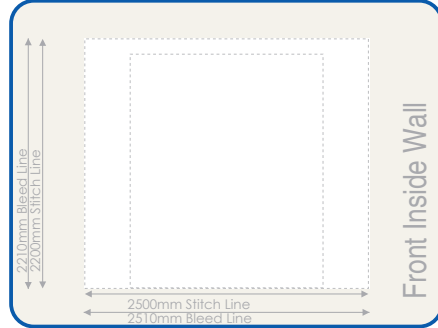

Front Inside Wall

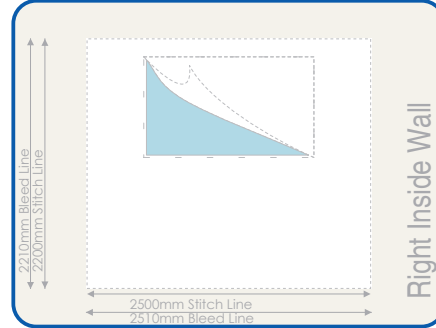

Right Inside Wall

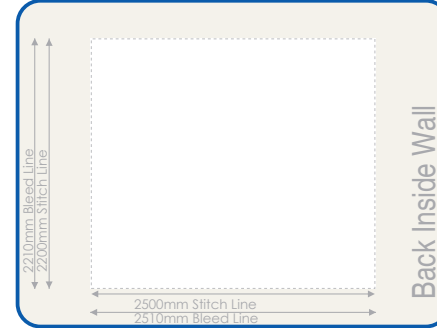

Back Inside Wall

Printed Sections:  
This template is designed to a 1% scale of the final product

**Artwork Note:**

**Please Note:**

All artwork is printed in CMYK colour space. To ensure your correct artwork please convert all to an equivalent CMYK breakup. Please be aware that slight colour variation may occur in the printing process from monitor to output. Rasterised artwork is printed at 300 dpi. We advise full sized artwork supplied at 300 dpi for best quality, we can work to 72dpi at a low quality print. Our visuals are copyright protected & are not be forwarded to other companies otherwise an art working fee will be enforced.

**Please check the following details are correct:**

1. All company details.
2. Spelling.
3. Phone numbers, Addresses + URL's.
4. Positioning of artwork.
5. Colours.
6. Correct size.

Please fax back to 01295 263750  
or sign, scan, attach & reply to your emailed quote.

Print Name. \_\_\_\_\_

Signature. \_\_\_\_\_

Quote reference:

# 2.5x2.5m Frame TBC

Printed Sections:

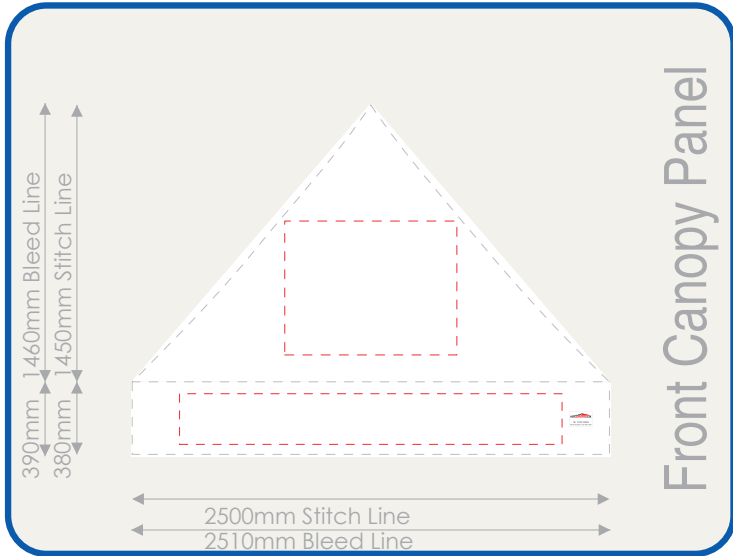

Front Canopy Panel

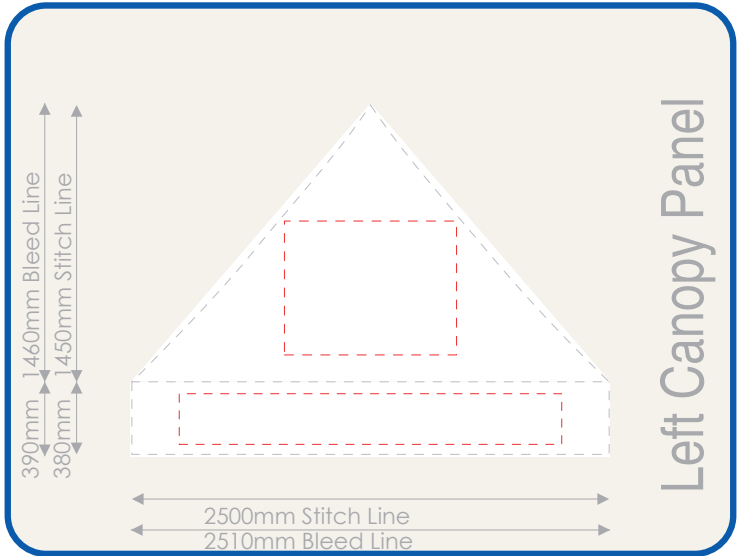

Left Canopy Panel

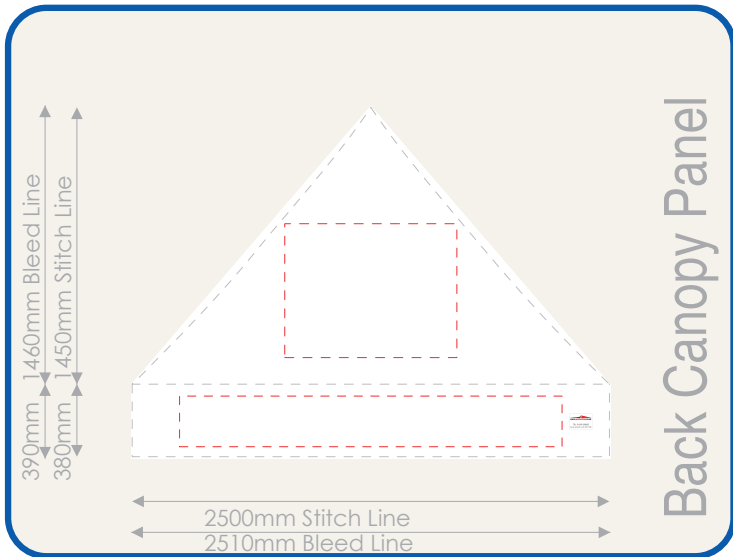

Back Canopy Panel

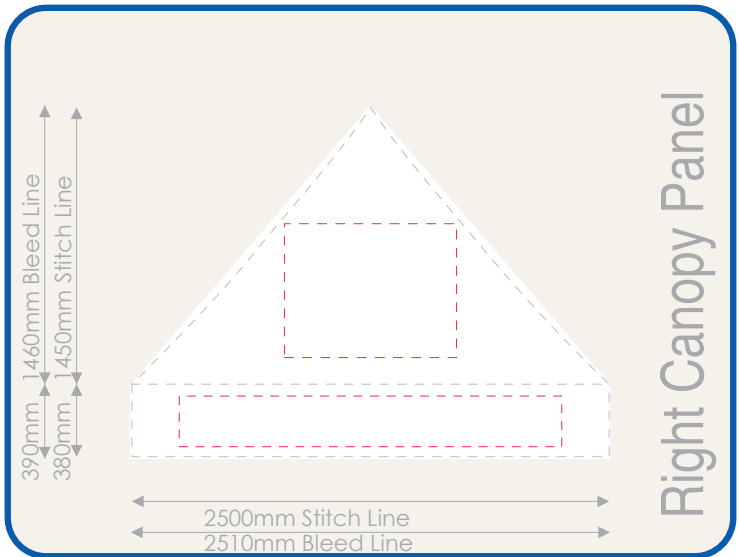

Right Canopy Panel

### Artwork Note:

### Red dotted boxes indicates our in house print areas

Please check the following details are correct:

- 1. All company details.
- 2. Spelling.
- 3. Phone numbers, Addresses + URL's.
- 4. Positioning of artwork.
- 5. Colours.
- 6. Correct size.

Please fax back to 01295 263750

or sign, scan, attach & reply to your emailed quote.

Print Name. \_\_\_\_\_

Signature. \_\_\_\_\_

### Please Note:

All artwork is printed in CMYK colour space. To ensure your correct artwork please convert all to an equivalent CMYK breakup. Please be aware that slight colour variation may occur in the printing process from monitor to output. Rasterised artwork is printed at 300 dpi. We advise full sized artwork supplied at 300 dpi for best quality, we can work to 72dpi at a low quality print. Our visuals are copyright protected & are not be forwarded to other companies otherwise an art working fee will be enforced.

Quote reference:

# 2.5x2.5m Frame TBC

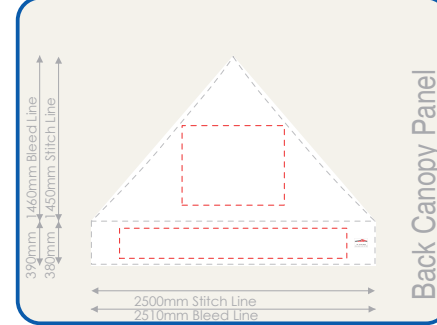
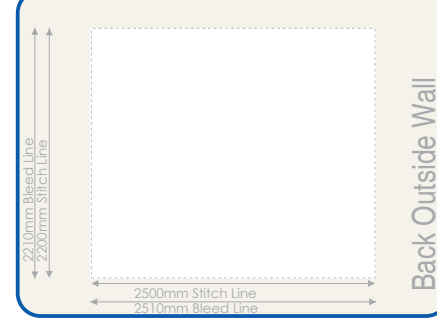
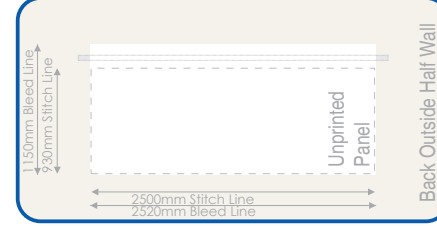
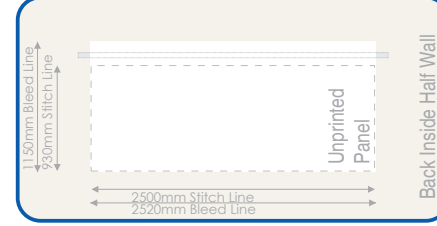
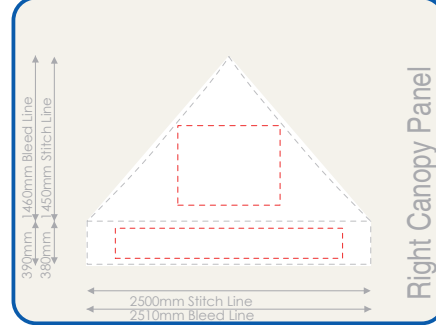
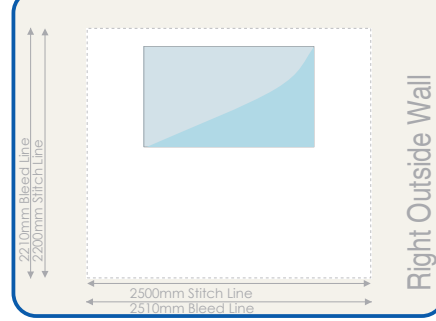
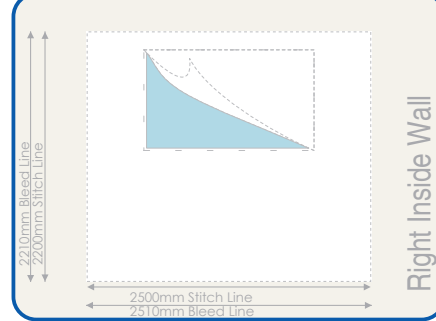
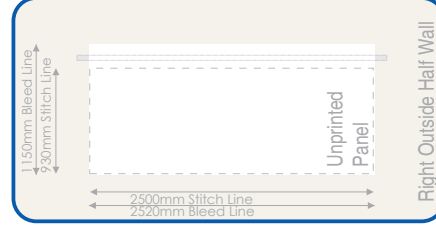
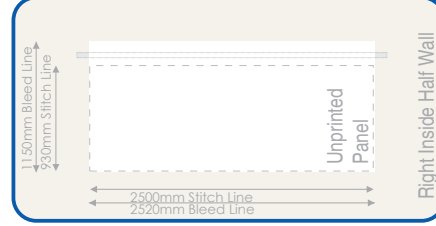
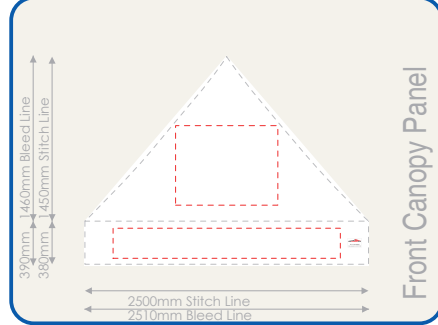
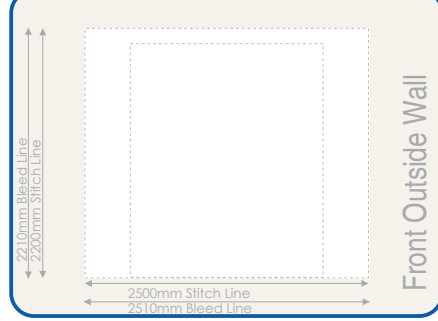
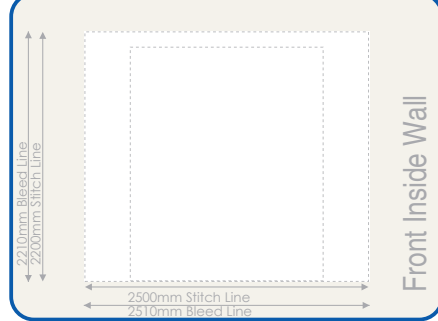
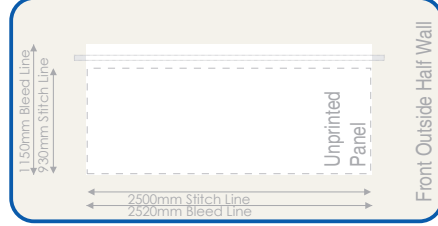
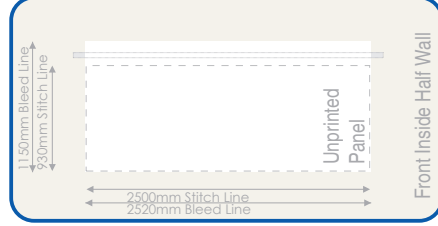
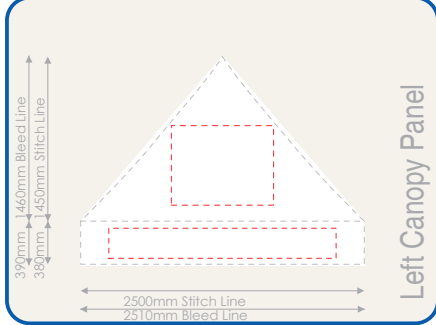
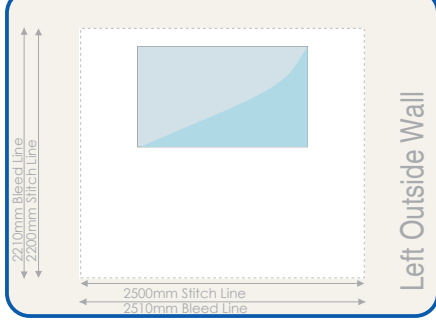
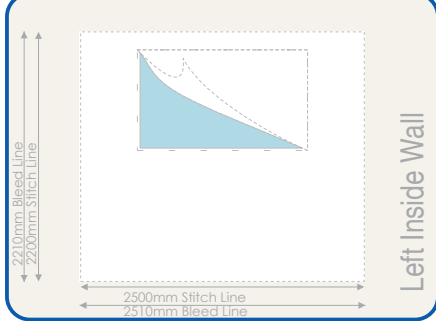
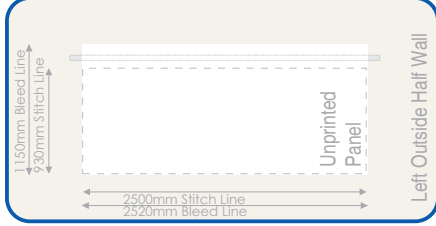
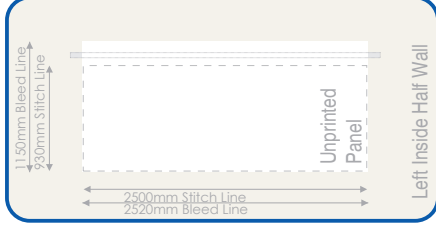

Printed Sections:

This template is designed to a 1% scale of the final product