

Quote reference:

3M x 4.5M Frame TBC

Printed Sections:

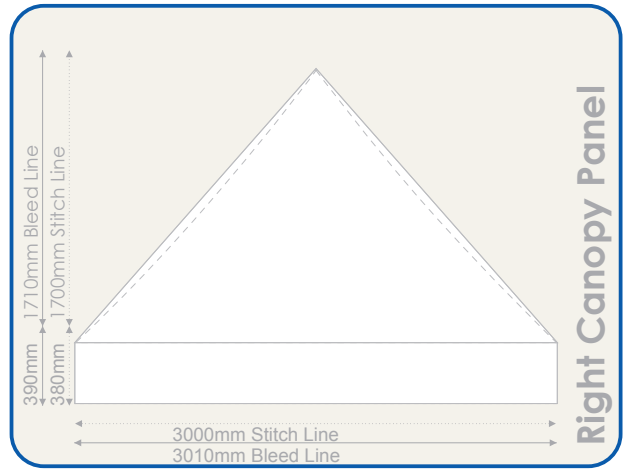
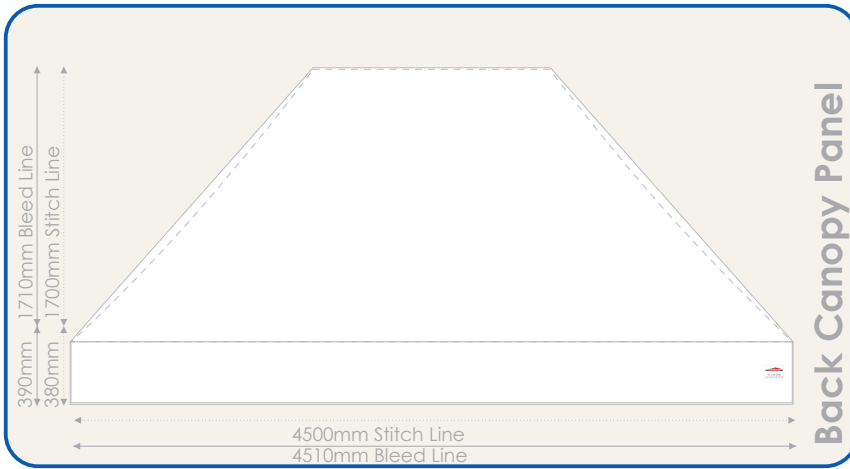
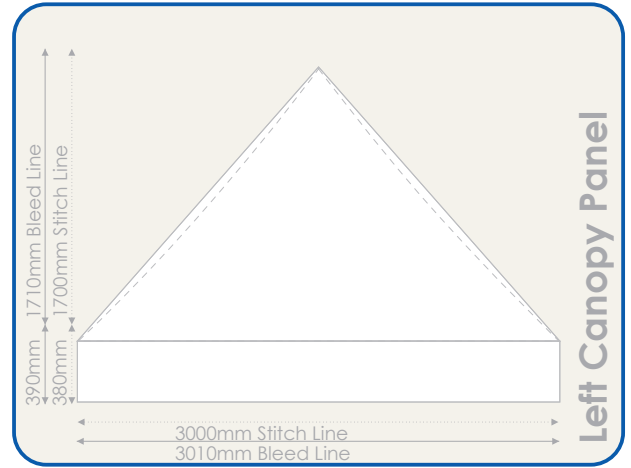
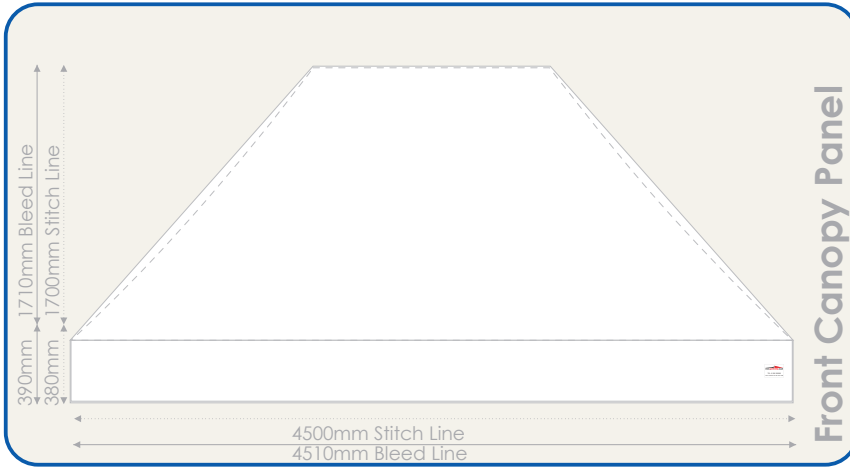

Artwork Note:

Please Note:

All artwork is printed in CMYK colour space. To ensure your correct artwork please convert all to an equivalent CMYK breakup with all fonts & strokes converted to outlines. Please be aware that slight colour variation may occur in the printing process from monitor to output. Rasterised artwork is printed at 300dpi. We advise full sized artwork supplied at 300dpi for best quality, we can work to 30dpi at a low quality print, Pixelation appears at 72dpi. Our visuals are copyright protected & are not be forwarded to other companies otherwise an art working fee will be enforced.

Please check the following details are correct:

- | | |
|---|--|
| 1. All company details. <input type="checkbox"/> | Please sign, scan, attach & reply to your emailed quote. |
| 2. Spelling. <input type="checkbox"/> | |
| 3. Phone numbers, Addresses + URL's. <input type="checkbox"/> | Print Name. _____ |
| 4. Positioning of artwork. <input type="checkbox"/> | |
| 5. Colours. <input type="checkbox"/> | |
| 6. Correct size. <input type="checkbox"/> | Signature. _____ |

This template is designed to a 1.5% scale of the final product
Printed Sections:

<p>Left Canopy Panel</p>	<p>Front Canopy Panel</p>	<p>Right Canopy Panel</p>	<p>Back Canopy Panel</p>
<p>Unprinted Panel Left Outside Wall</p>	<p>Unprinted Panel Front Outside Wall</p>	<p>Unprinted Panel Right Outside Wall</p>	<p>Unprinted Panel Back Outside Wall</p>
<p>Unprinted Panel Left Inside Wall</p>	<p>Unprinted Panel Front Inside Wall</p>	<p>Unprinted Panel Right Inside Wall</p>	<p>Unprinted Panel Back Inside Wall</p>

Artwork Note:

Please Note:
All artwork is printed in CMYK colour space. To ensure your correct artwork please convert all to an equivalent CMYK breakup with all fonts & strokes converted to outlines. Please be aware that slight colour variation may occur in the printing process from monitor to output. Rasterised artwork is printed at 300dpi. We advise full sized artwork supplied at 300dpi for best quality, we can work to 30dpi at a low quality print, Pixelation appears at 72dpi.
Our visuals are copyright protected & are not be forwarded to other companies otherwise an art working fee will be enforced.

Please check the following details are correct:

1. All company details.
2. Spelling.
3. Phone numbers, Addresses + URL's.
4. Positioning of artwork.
5. Colours.
6. Correct size.

Please sign, scan, attach & reply to your emailed quote.

Print Name. _____

Signature. _____

Printed Sections:

This template is designed to a 1.5% scale of the final product

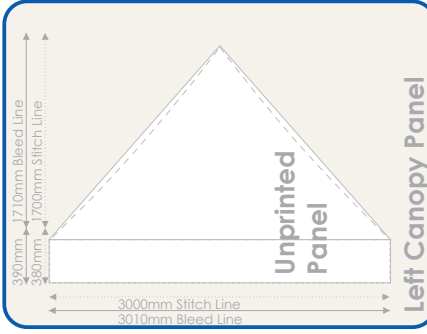

Left Canopy Panel

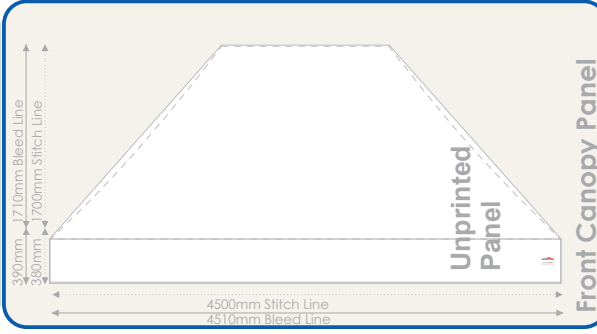

Front Canopy Panel

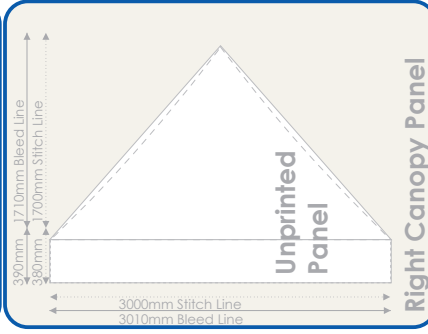

Right Canopy Panel

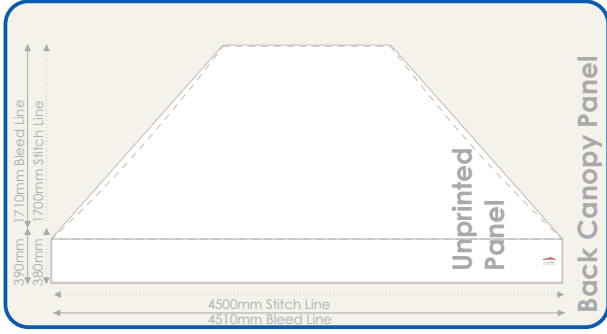

Back Canopy Panel

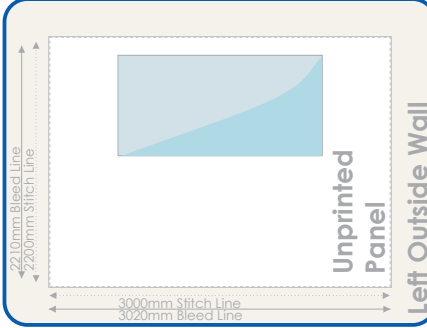

Left Outside Wall

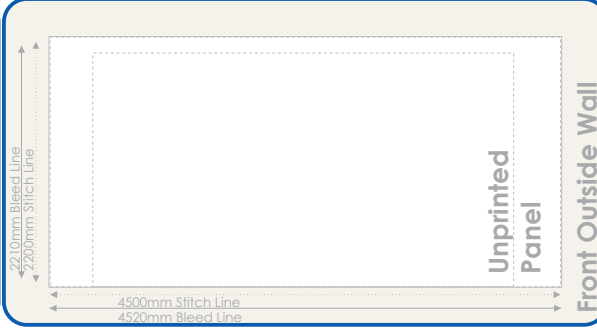

Front Outside Wall

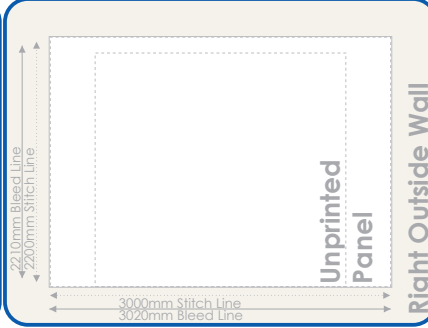

Right Outside Wall

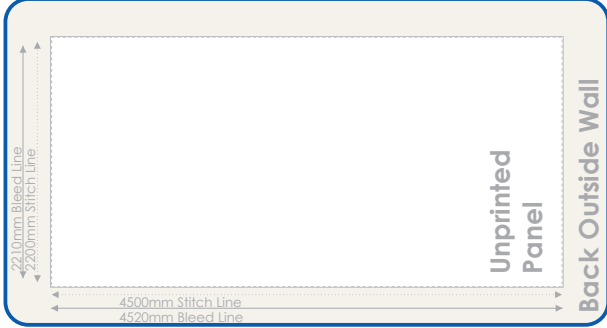

Back Outside Wall

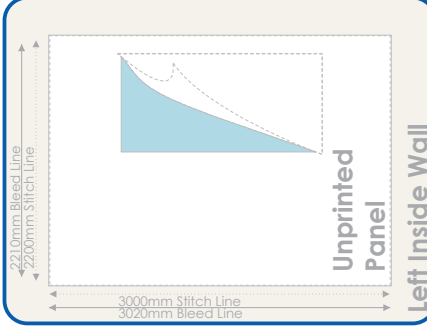

Left Inside Wall

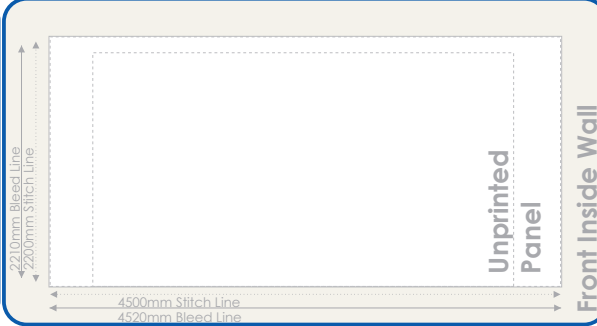

Front Inside Wall

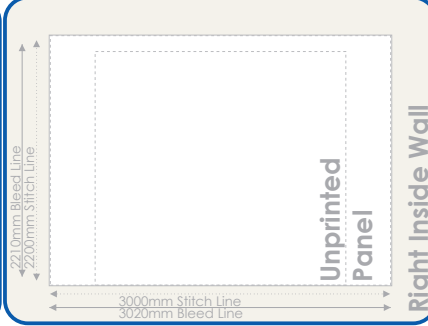

Right Inside Wall

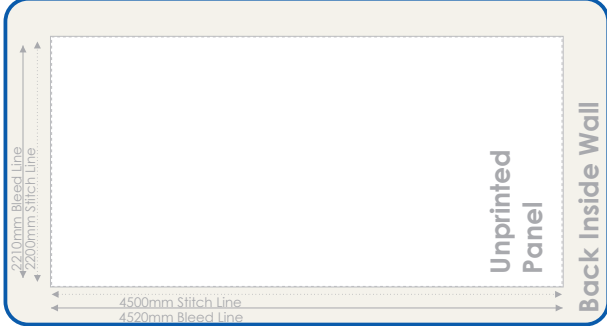

Back Inside Wall

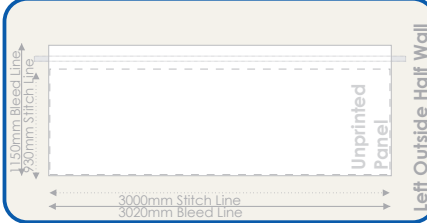

Left Outside Half Wall



Front Outside Half Wall

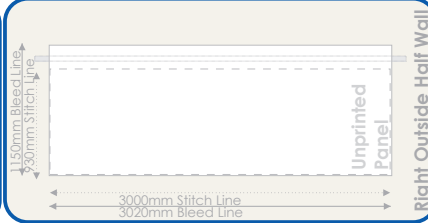

Right Outside Half Wall



Back Outside Half Wall

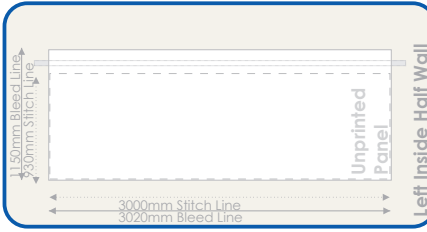

Left Inside Half Wall

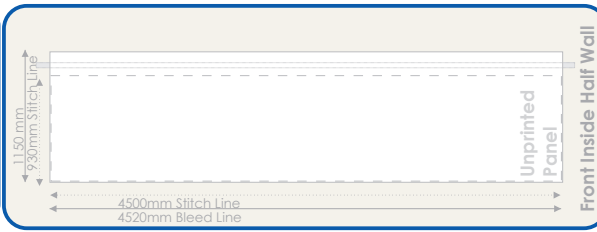

Front Inside Half Wall

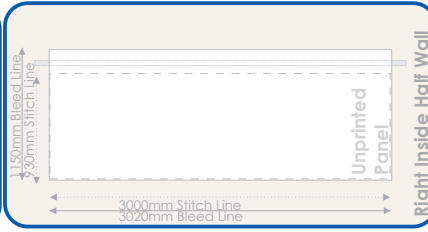

Right Inside Half Wall

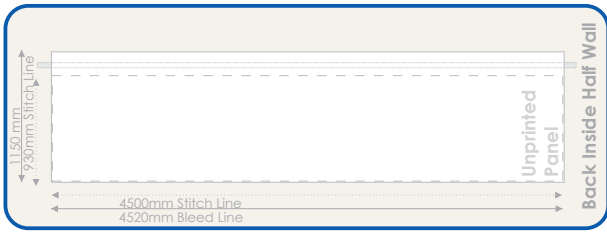

Back Inside Half Wall